

Przed rozpoczęciem montażu proszę zapoznać się z instrukcją.  
 Before installation, please read the the instructions.  
 Vor der Montage bitte die Anleitung genau lesen.  
 Před zahájením montáže se seznamte s návodem.  
 Pred začiatkom montáže si prečítajte návod.  
 A szerelés folyamat megkezdése előtt kérem, hogy figyelemesen olvassa át a szerelési utasítást.

Narzędzia niezbędne do montażu (nie dostarczane przez producenta)  
 Tools required for assembly (not provided by the manufacturer)  
 Für die Montage notwendige Werkzeuge (nicht vom Hersteller mitgeliefert)  
 Nástroje nezbytné pro montáž (nejsou dodávány výrobcem)  
 Nástroje nevyhnutné pre montáž (nedodávané výrobcom)  
 A szereléshez szükséges szerszámokat (a Gyártó nem biztosítja)

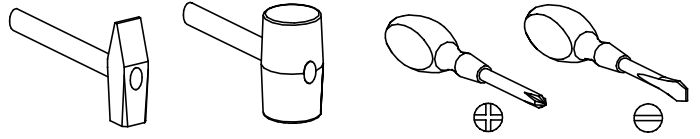

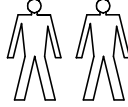







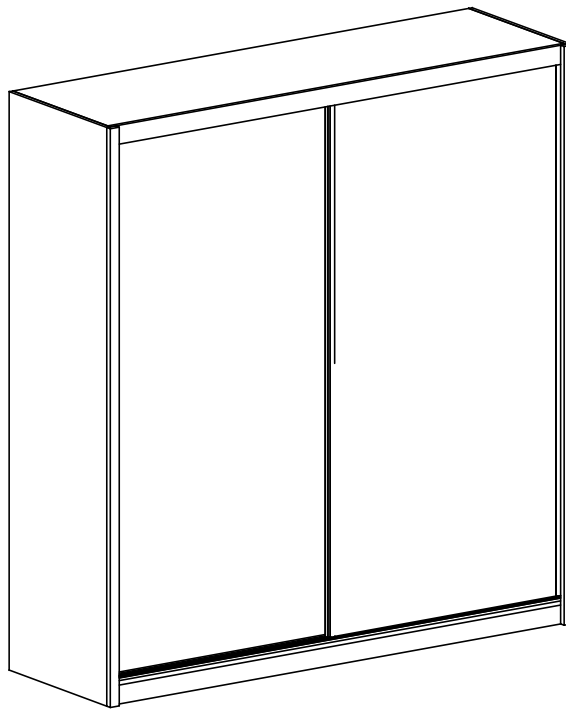





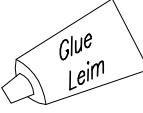



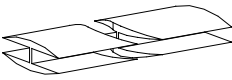
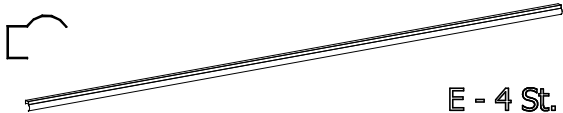

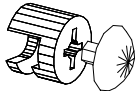
150 min

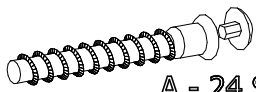

INSTRUKCJA MONTAŻU  
 ASSEMBLY INSTRUCTIONS  
 MONTAGEANLEITUNG  
 NÁVOD NA MONTÁŽ  
 NÁVOD NA MONTÁŽ  
 SZERELÉSI UTASÍTÁS

TURYN 203  
 BATUMI 203

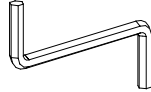

 S - 8 St.	 M - 2 St.		 Q - 8 St. 5 x 13 mm	
 O - 12 St.	 Glue Leim Y - 1 St.	 SZ - 2 St.	 U - 24 St.	 R - 8 St.
 H - 1 St.	 E - 4 St.	 N - 4 St.	 D - 4 St.	
 T - 1 St.	 F - 100 St.	 G - 16 St. 4 x 13 mm	 K - 4 St.	 C - 4 St.
 A - 24 St. 7 x 50 mm	 B - 36 St.	 P - 2 St.	 Z - 1 St.	 L - 16 St. 6 x 13 mm

1

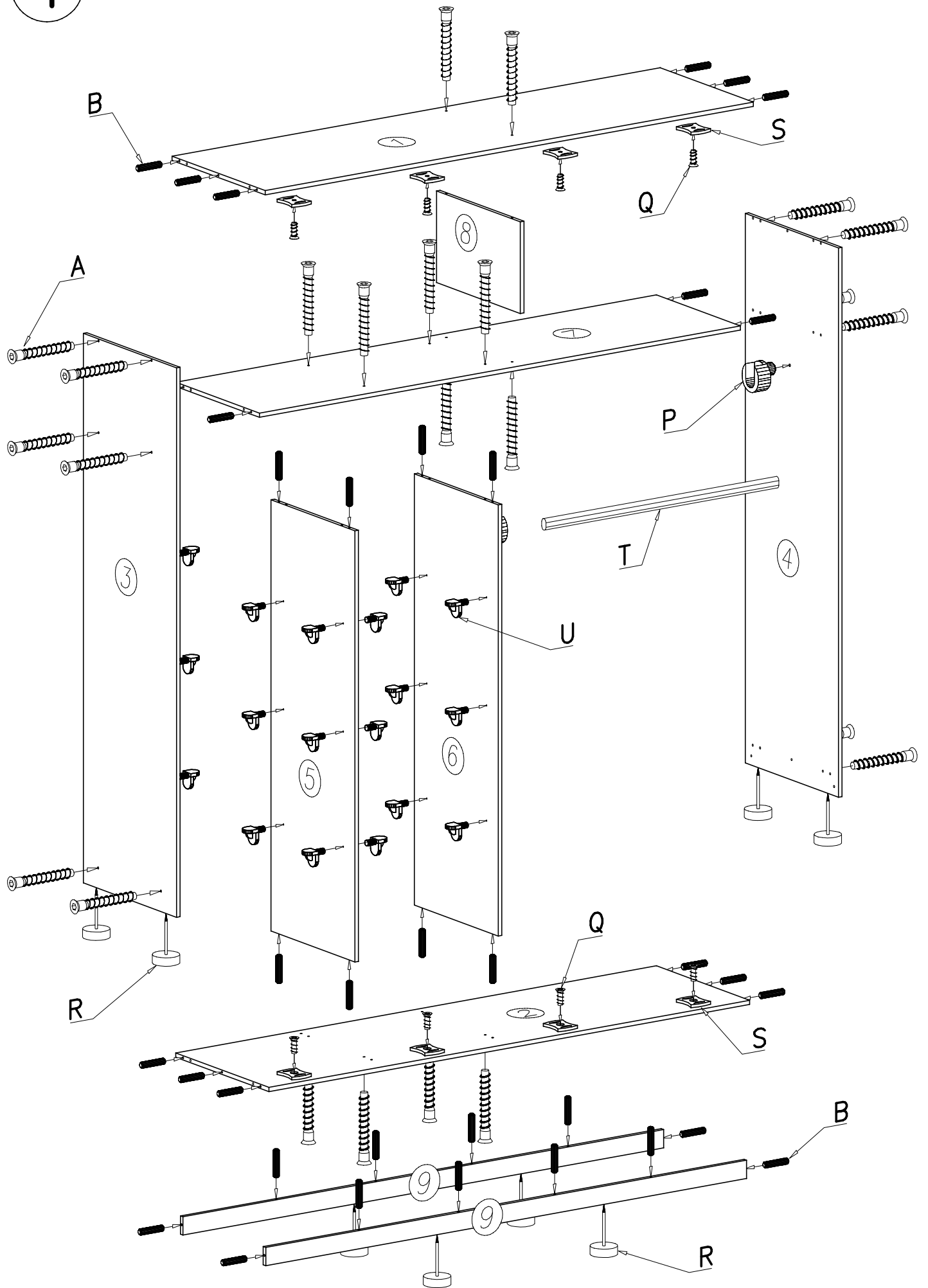

2

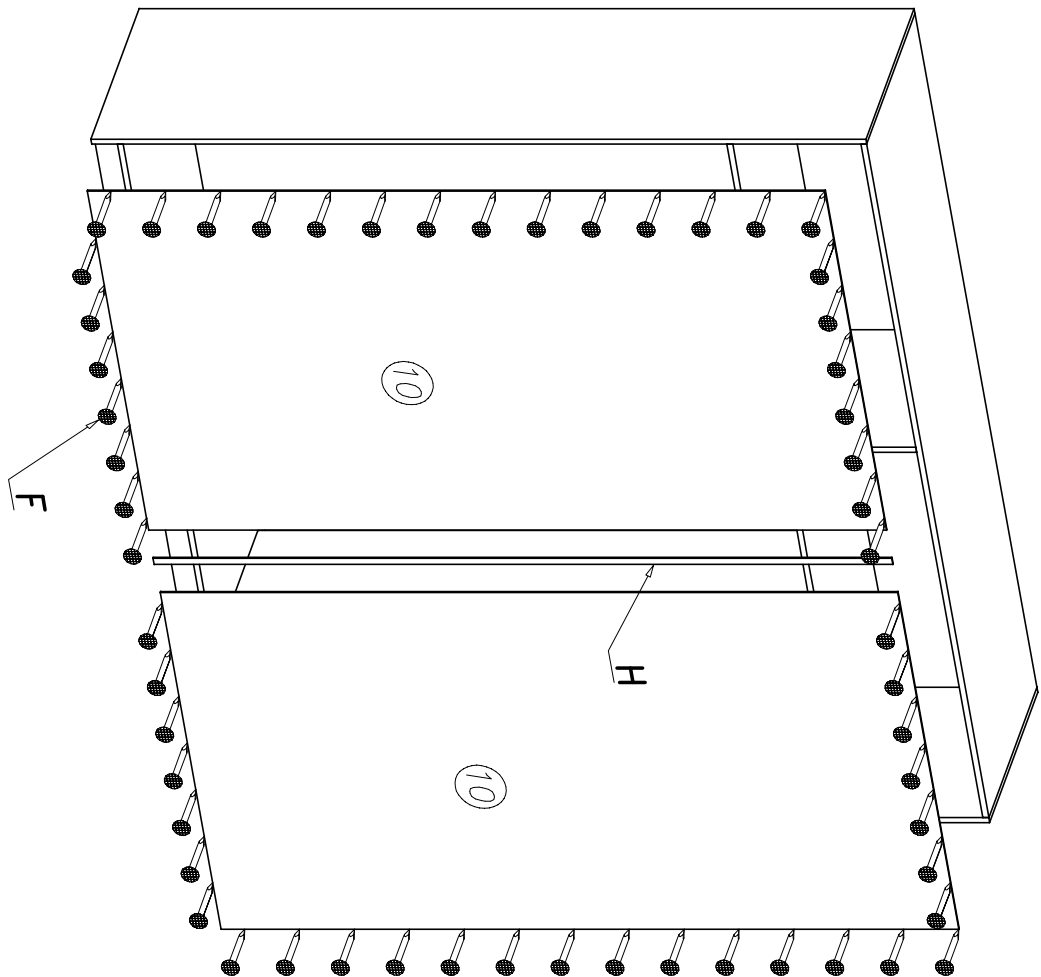

$$a = b$$

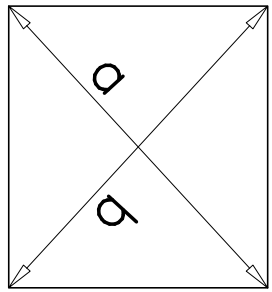

3

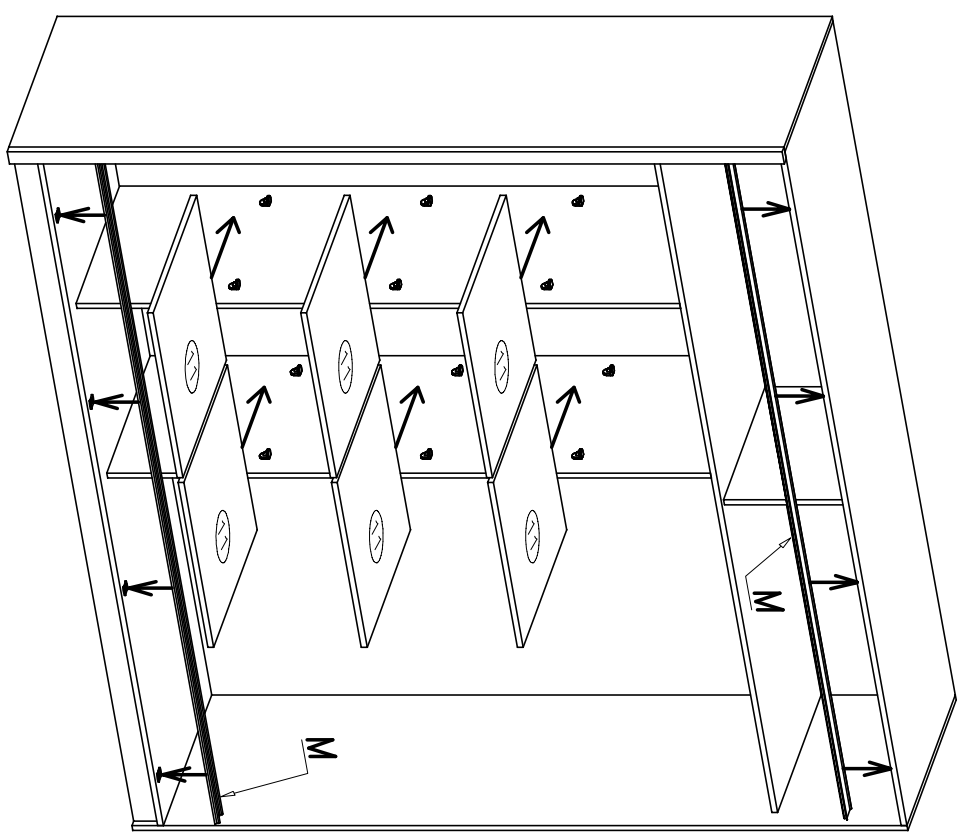

4

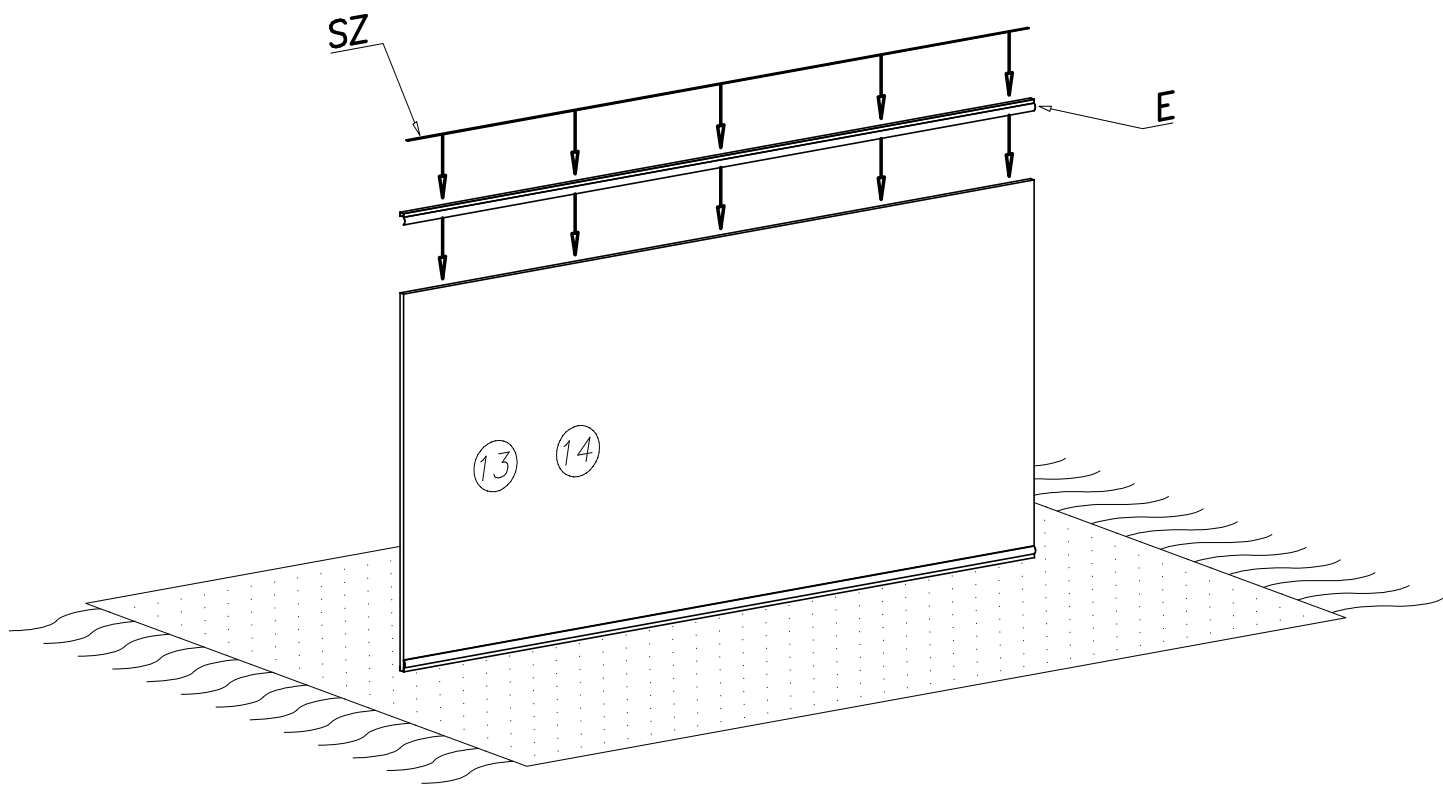
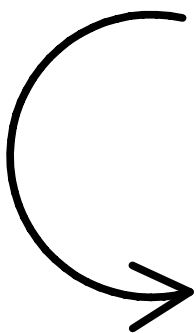
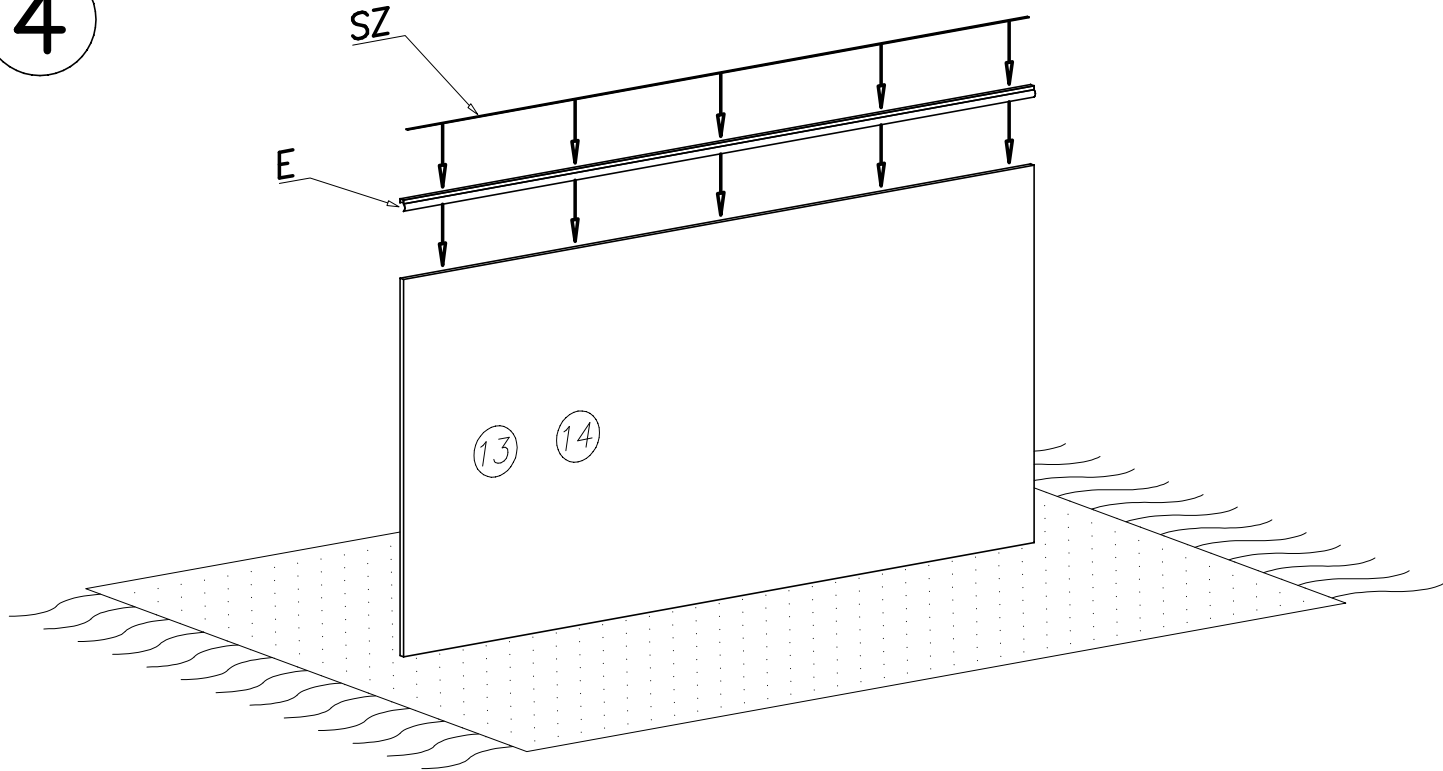

5

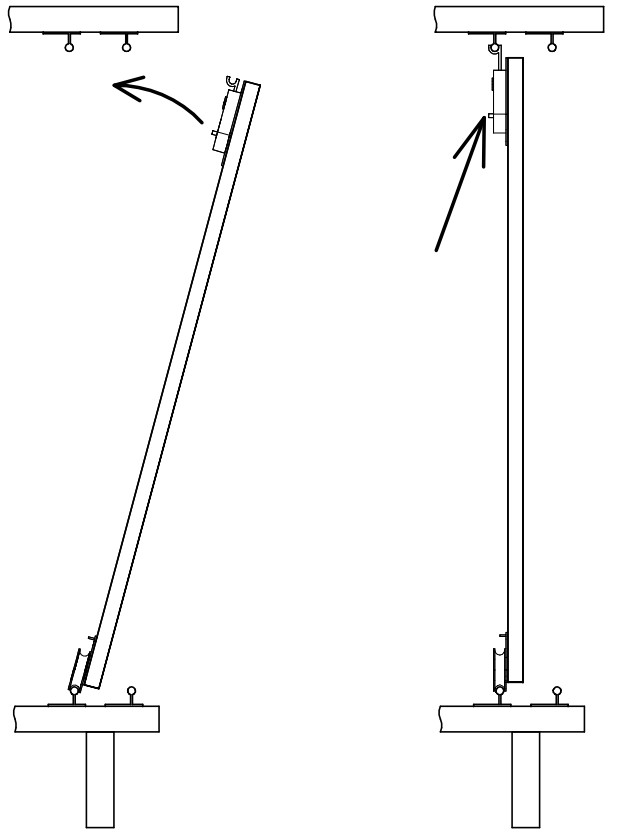
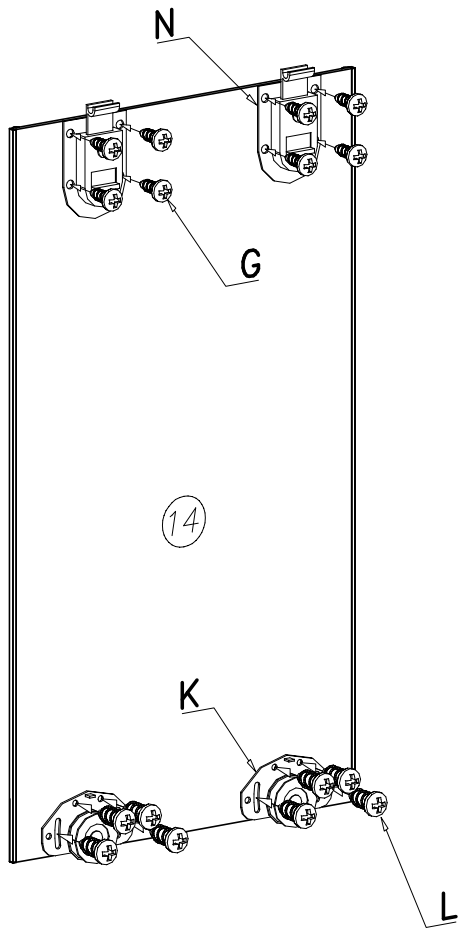

6

