

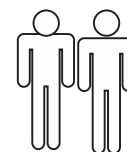

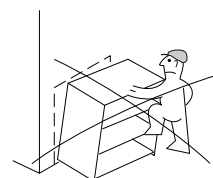

Komoda niska

Instrukcja montażu

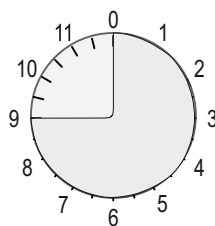
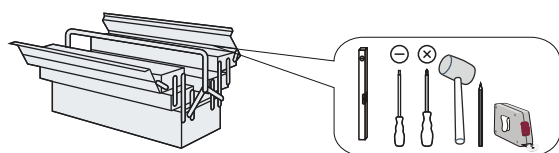
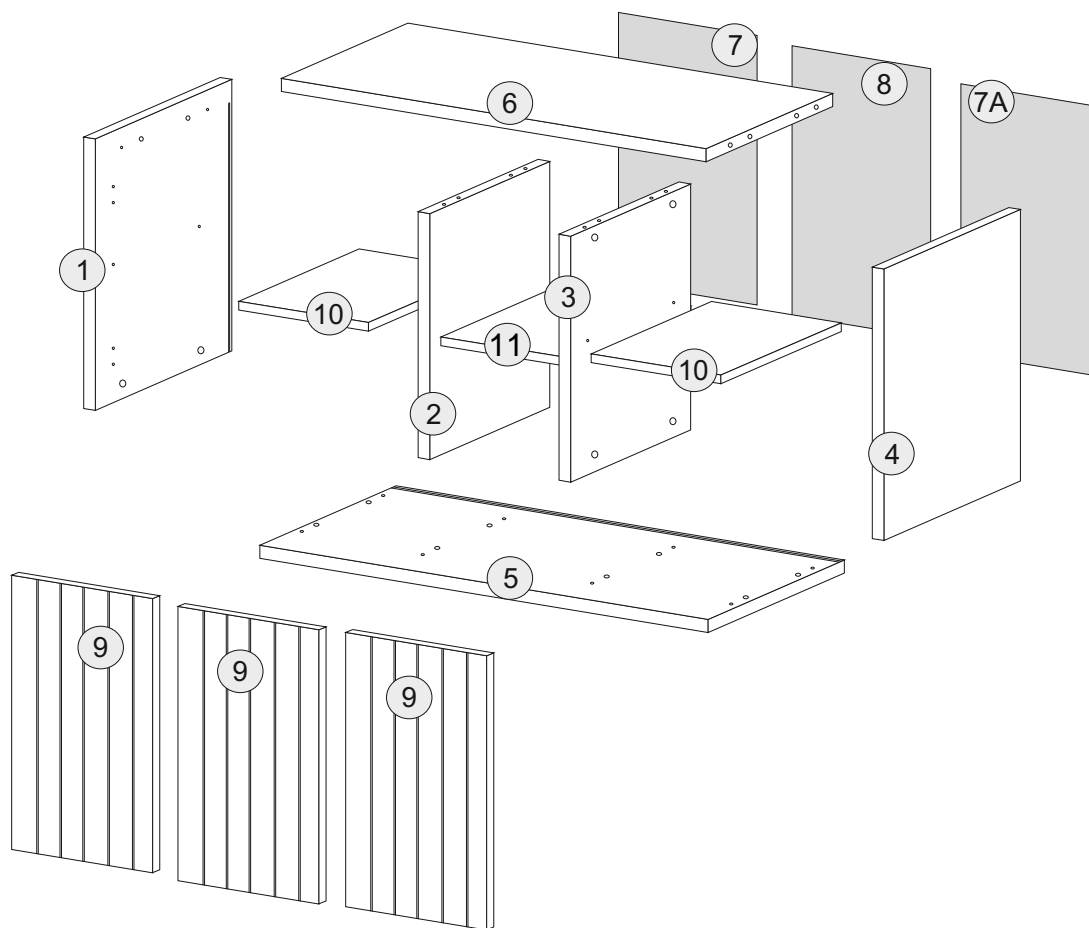
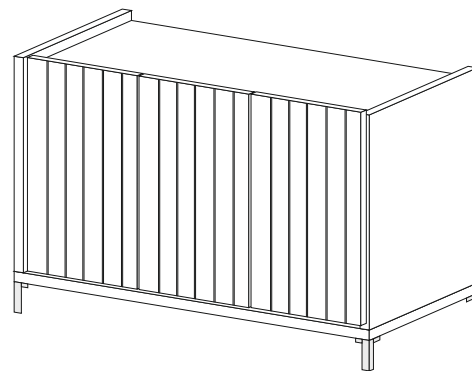
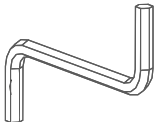
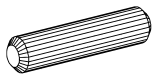
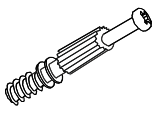

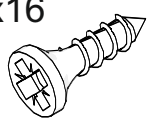
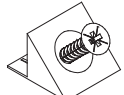
A  x1	B  x16	C  x16	D  x16
D1  x16	W4 4x16  x32	S  x12	J  x12
E1  x4	E2  x6	E3  x2	T  x4
T1  x1			

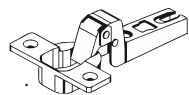
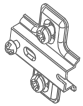
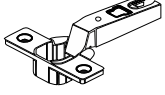
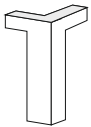
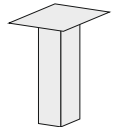
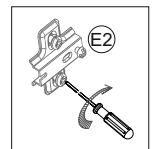
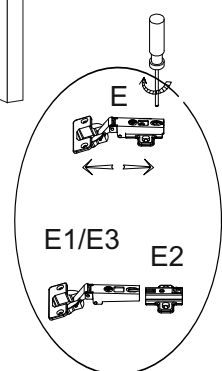
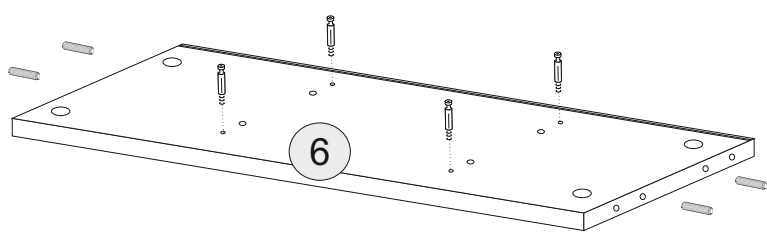
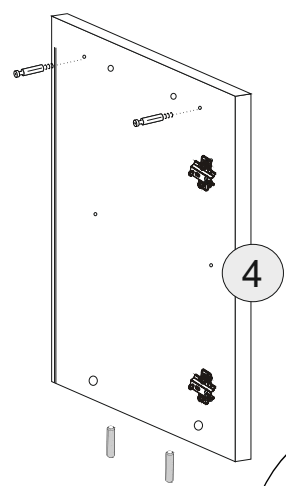
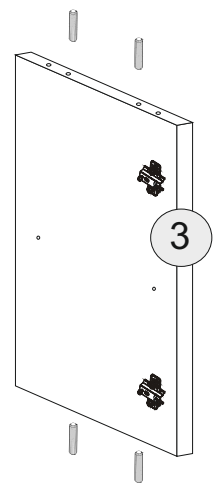
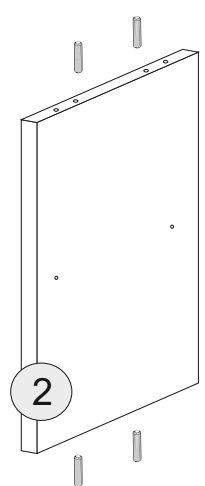
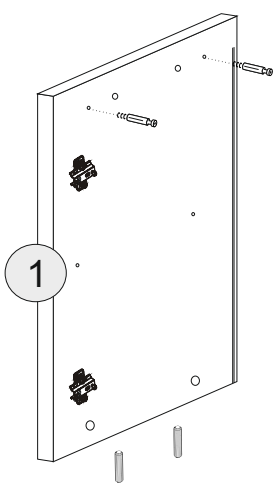
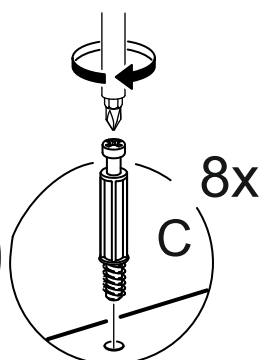
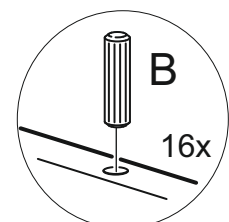
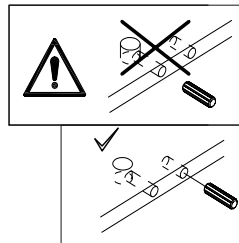
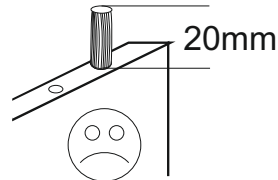
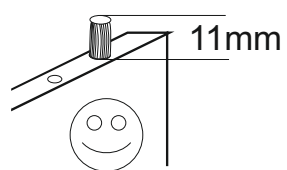

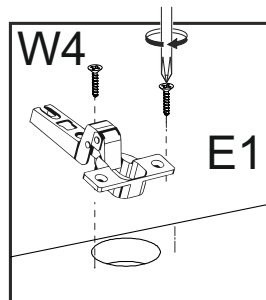
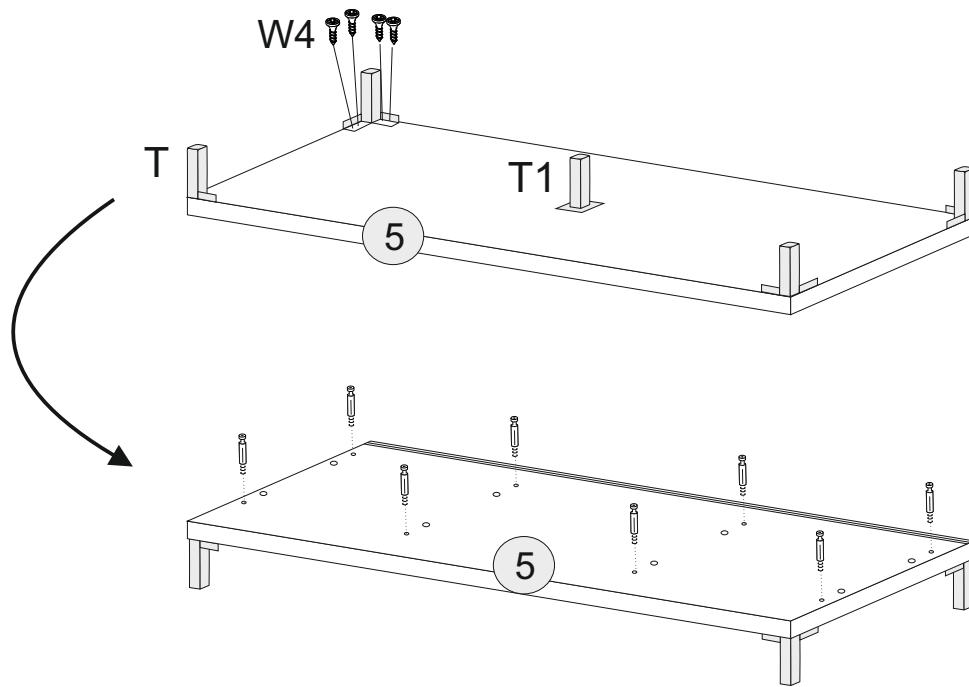

x2

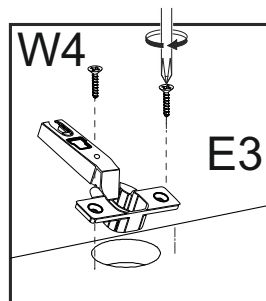
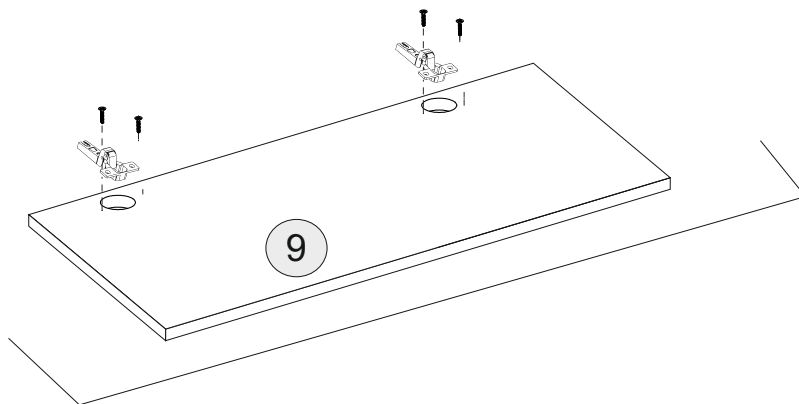

x1

